

High Bay Light

Security
Reliability

Energy saving
Smart control



Patent protection

HBL60W-240W



High Bay Light

GTL Lighting(Shen Zhen)Co.,Ltd.

Application places



Factory



Warehouse



High Ceiling



Public Area

<http://www.gtlighting.com/>

High Bay Light

GTL Lighting(Shen Zhen)Co.,Ltd.

The main characteristics

Safe



Reliability



Energy saving



Smart control



<http://www.gtlighting.com/>

HBL 60/80/100/120/150/200/240W	
HBL-MW 	HBL-MOSO 
<p>The industry's first water-wave circular lens (patented design).its optical loss is only 3% . Circular lens design also provides great convenience to customized projects .More than 200,000pcs are sold worldwide every year, more and more customers are benefiting from this high performance and high reliability product.</p>	

- The workshop
- warehouse
- Airport, station, stadium
- Other industrial and commercial buildings

High Bay Light

Product summary

GTL Lighting(Shen Zhen)Co.,Ltd.



SRGE

- * 60W-240W
- * 90-305VAC
- * 4000K/5000K/5700K
- * 9000-36000lm
- * 150lm/W
- * On/Off (0-10V)
- * CRI>70
- * No flicker
- * SDCM<5
- * Surge 4KV/6KV
- * 50,000 hrs @ Ta45°C
- * IP65, IK10
- * Hook / Pendant/ Bracket Mount

- * ETL,CE,C-TICK,ROHS
- * 5years warranty

Very short payback time

Traditional HID 400W

HBL150W

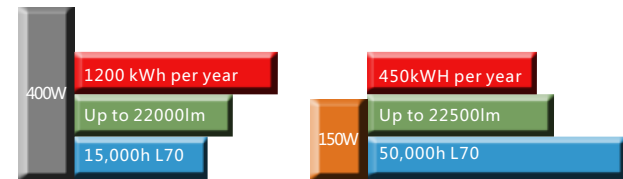

Fit for different applications

- *Multiple lumen output
- * Multiple mounting method
- *Optional reflector
- * IP65
- * Die-casting housing, IK10

5 years warranty



Power	60W	80W 100W	120W 150W	200W 240W
Size (mm)	261*261*118	261**261*172	300*300*190	330*330*201
Lumen(lm)	9000lm	12000 Lm 15000 Lm	18000 Lm 22500Lm	30000 Lm 36000Lm
EFF (lm/w)	150lm/W			
Beam Angle	60°/90°/120°			



<http://www.gttlighting.com/>

High Bay Light

GTL Lighting(Shen Zhen)Co.,Ltd.

Product model

HBL-MW

HBL-MOSO

HBL
60W



HBL
80/100W



HBL
120/150W



HBL
200/240W



<http://www.gtlighting.com/>

High Bay Light

Specifications

GTL Lighting(Shen Zhen)Co.,Ltd.

		HBL60W	HBL80/100W	HBL120/150W	HBL200/240W
Power		60W	80/100W	120/150W	200/240W
Input Voltage		90-305VAC			
Input Current		0.27A@220VAC	0.36A@220VAC 0.45A@220VAC	0.55A@220VAC 0.68A@220VAC	0.91A@220VAC 1.10A@220VAC
PF		>0.90@220VAC			
DC output voltage		54V	48V		
DC output current		1.05A	1.5A/1.9A	2.3A/2.9A	3.9A/4.65A
Dimming (Optional)		3 in 1 dimming (PWM, 0-10V, Resistor), Dali			
CCT		4000K, 5000K, 5700K, 3000K			
Ra > 80, 5000 k	Luminous Flux	8400 Lm±10%	11200Lm±10% 14000Lm±10%	16800Lm±10% 21000Lm±10%	28000Lm±10% 33600Lm±10%
	Efficiency	140Lm/W±10%			
Ra > 70, 5000 k	Luminous Flux	9000 Lm±10%	12000Lm±10% 15000Lm±10%	18000Lm±10% 22500Lm±10%	30000Lm±10% 36000Lm±10%
	Efficiency	150Lm/W±10%			
LED Brand		Nichia 3030 and Lumileds 3030			
Beam Angle		60°/90°/120°			
Operation Temp		-40°C ~ +45°C			
Storage Temp		-40°C ~ +85°C			
Life Span		45°C 50000hours			
IP Class		IP65			
IK Class		IK10			
Certificate		ETL,CE,C-TICK,ROHS			
Lamp Body Color		Black (default with RAL9005), Gray (optional for RAL9007)			
MOSO	Product Size (mm)	261*261*188	261*261*188	300*300*208	330*330*218
	Net weight (kg) ±0.1	2.89Kg	2.89Kg	3.87Kg	6.11Kg
	Packing Size (mm)	325*325*230	325*325*230	370*370*245	400*400*255
	Grossweight (kg)±0.1	3.65Kg	3.65	4.79Kg	7.21Kg
MW	Product Size (mm)	261*261*188	261*261*172	300*300*190	330*330*201
	Net weight (kg) ±0.1	2.27Kg	2.95Kg	3.97Kg	6.11Kg
	Packing Size (mm)	325*325*230	325*325*230	370*370*245	400*400*255
	Grossweight (kg)±0.1	3.04Kg	3.7Kg	4.88Kg	7.21Kg
Installation mode		Hook /Pendant /Bracket Mount			

<http://www.gtlighting.com/>

High Bay Light

Safe/Reliability

GTL Lighting(Shen Zhen)Co.,Ltd.

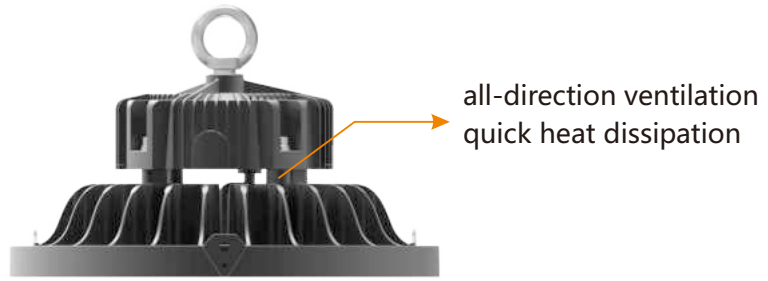
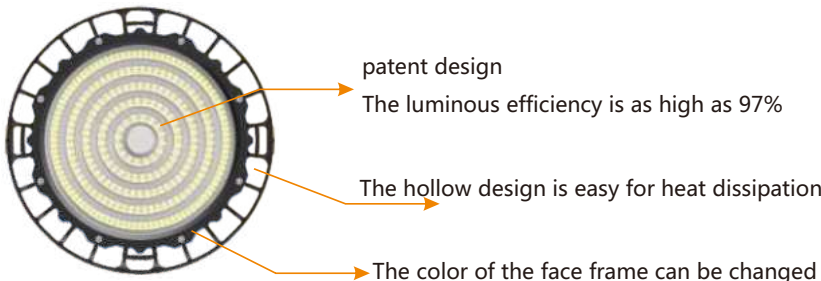
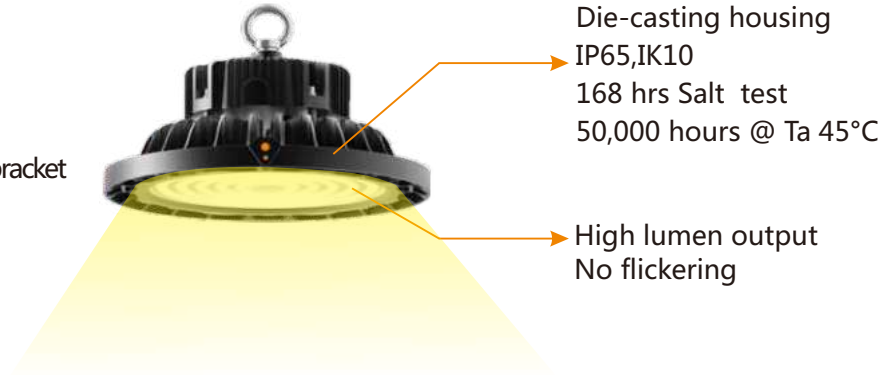
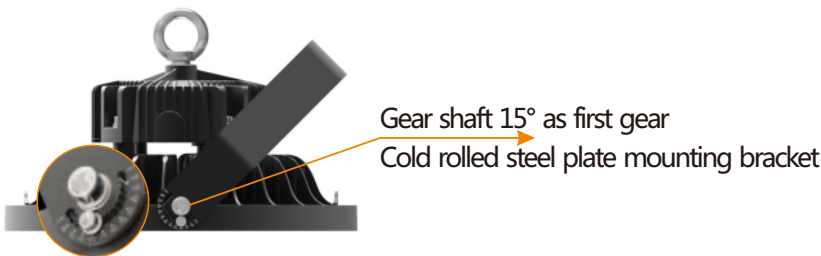

<http://www.gtlighting.com/>

High Bay Light

GTL Lighting(Shen Zhen)Co.,Ltd.

Configuration table

Configuration							
product name	Product category	Power	CRI	CCT	Distribution	Control	SPD
HBL	High bay	60*/80*/100W	>70	3000/ 4000K	30°/60°	ON/OFF	NO
		120/150/160W	>80	5000/ 5700K	90°	PWM, 0-10V Resistor	
		200*/240W	>90	6500K	120°	DALI	

"*" Able to be customized, and please contact PM directly

<http://www.gtlighting.com/>

Customizable table

	Current	Certification Available	Possibility	Note
Power	100/120/150/ 160/240W	Yes	60/80/200W	The custom code
CCT	3000/4000/ 5000/5700/ 6500K	Yes		The luminous flux will change due to CCT
Beam Angle	60°/90°/120°	Yes	30°	New tooling is required
Control	ON/OFF,0-10V, PWM,DALI	Yes	Microwave	Product out look will be different

High Bay Light

GTL Lighting(Shen Zhen)Co.,Ltd.

Model description

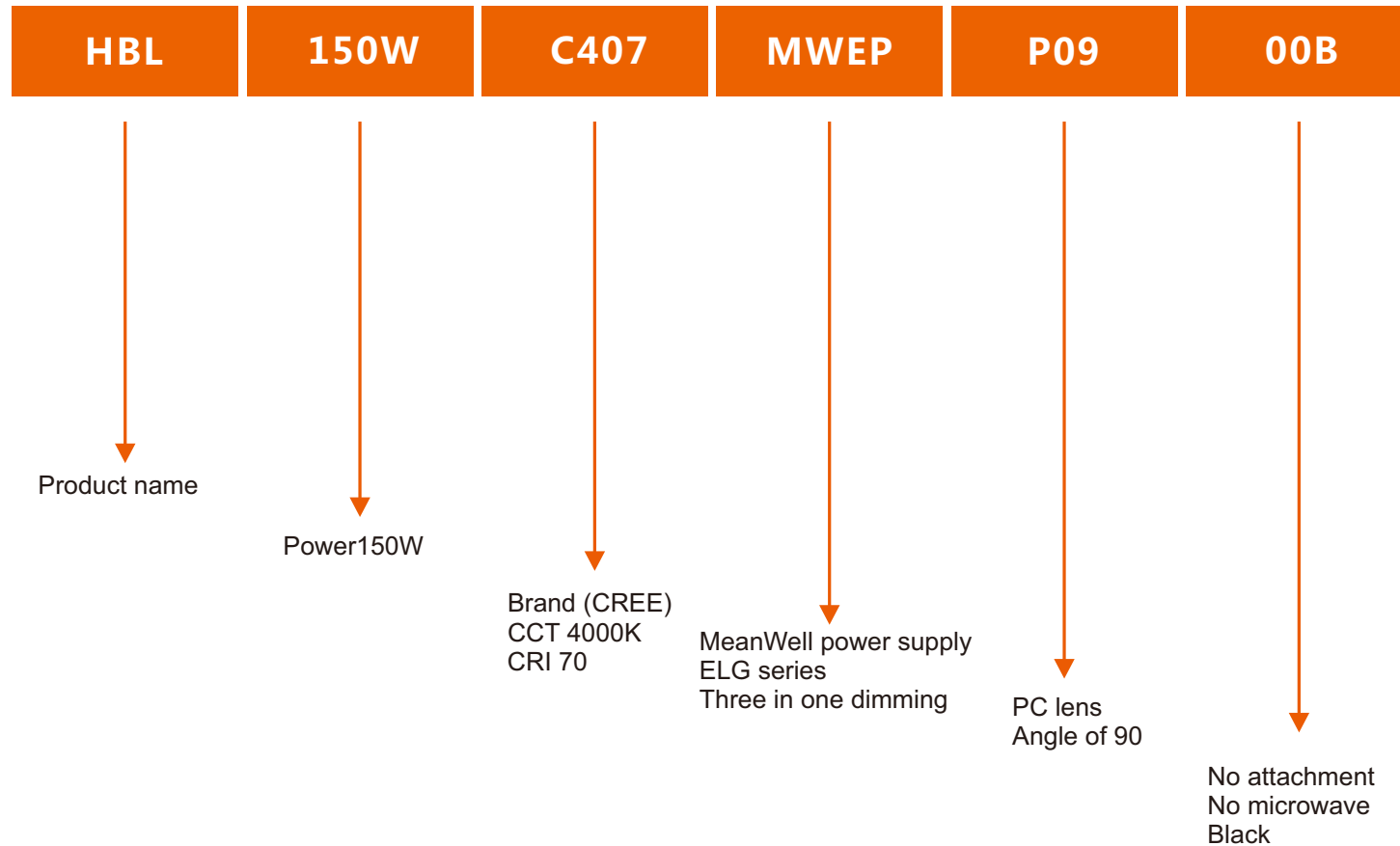

<http://www.gtlighting.com/>

High Bay Light

Installation Guide

GTL Lighting(Shen Zhen)Co.,Ltd.

HBL-MW

Wiring diagram

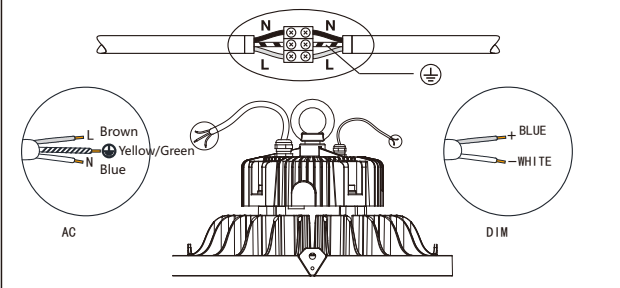

1- Hook Mount

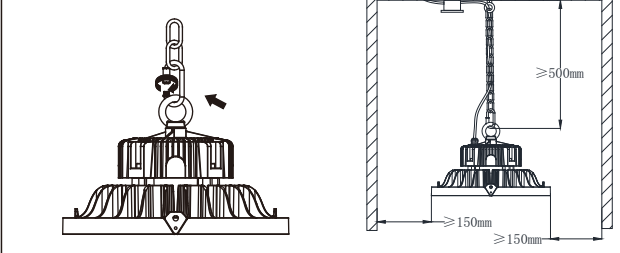

2- Pendant Mount

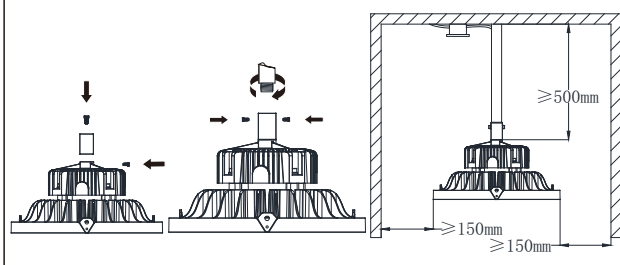

3- Bracket Mount

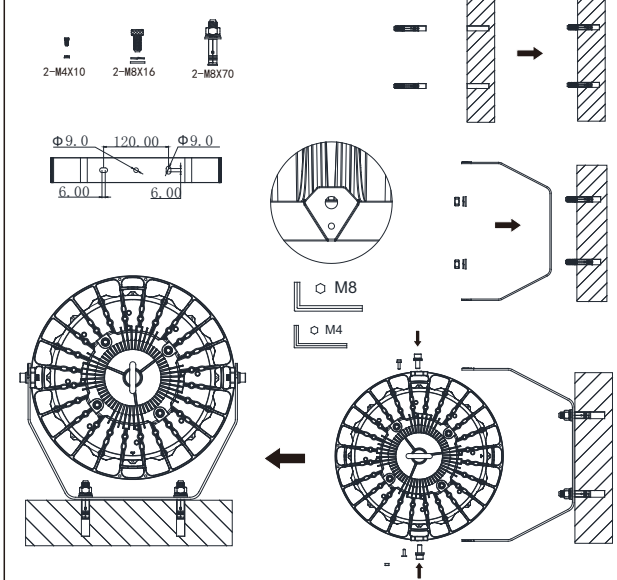

For all of the above installation, it is recommended that all models with safety rope.

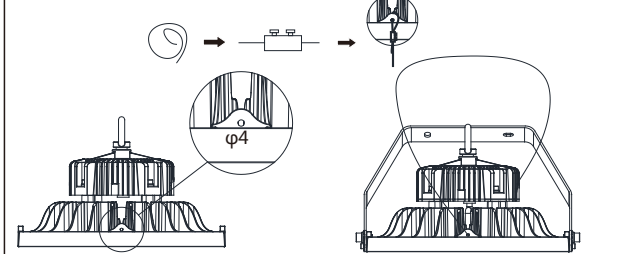

<http://www.gtlighting.com/>

High Bay Light

Installation Guide

GTL Lighting(Shen Zhen)Co.,Ltd.

HBL-MOSO

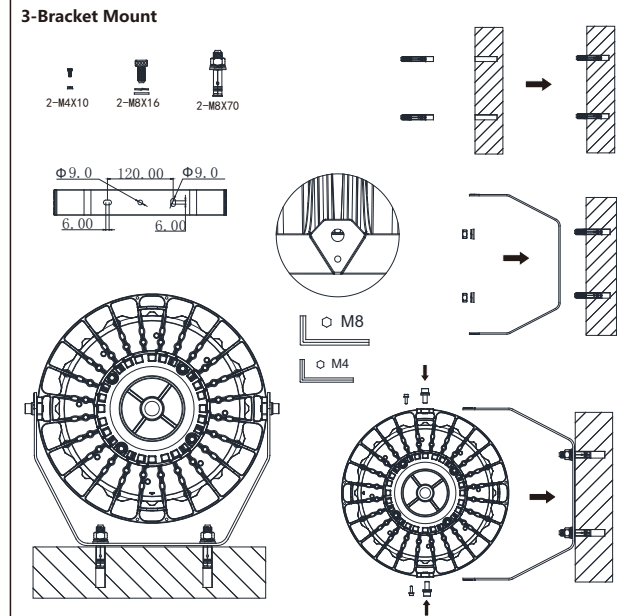
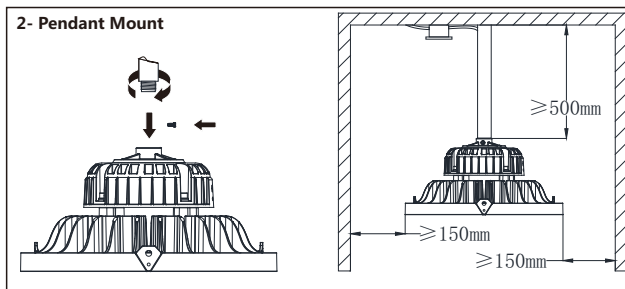
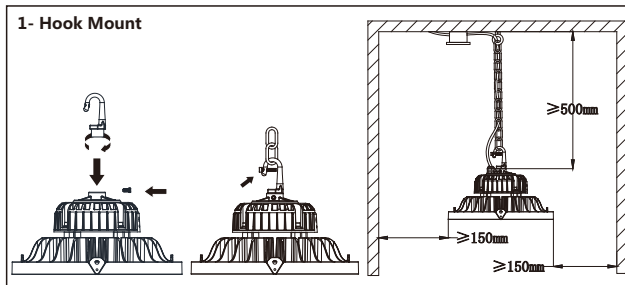
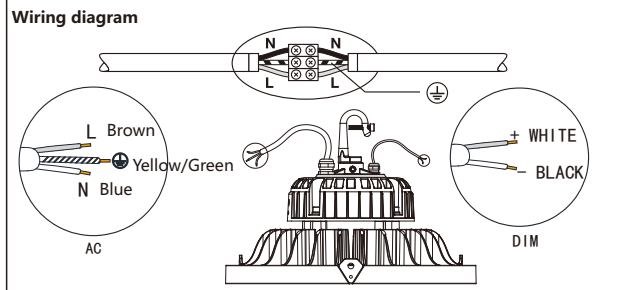

For all of the above installation, it is recommended that all models with safety rope.

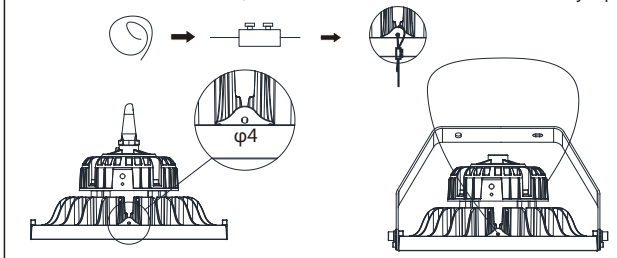

<http://www.gtlighting.com/>

High Bay Light

GTL Lighting(Shen Zhen)Co.,Ltd.

Container volume calculation

Unit : mm

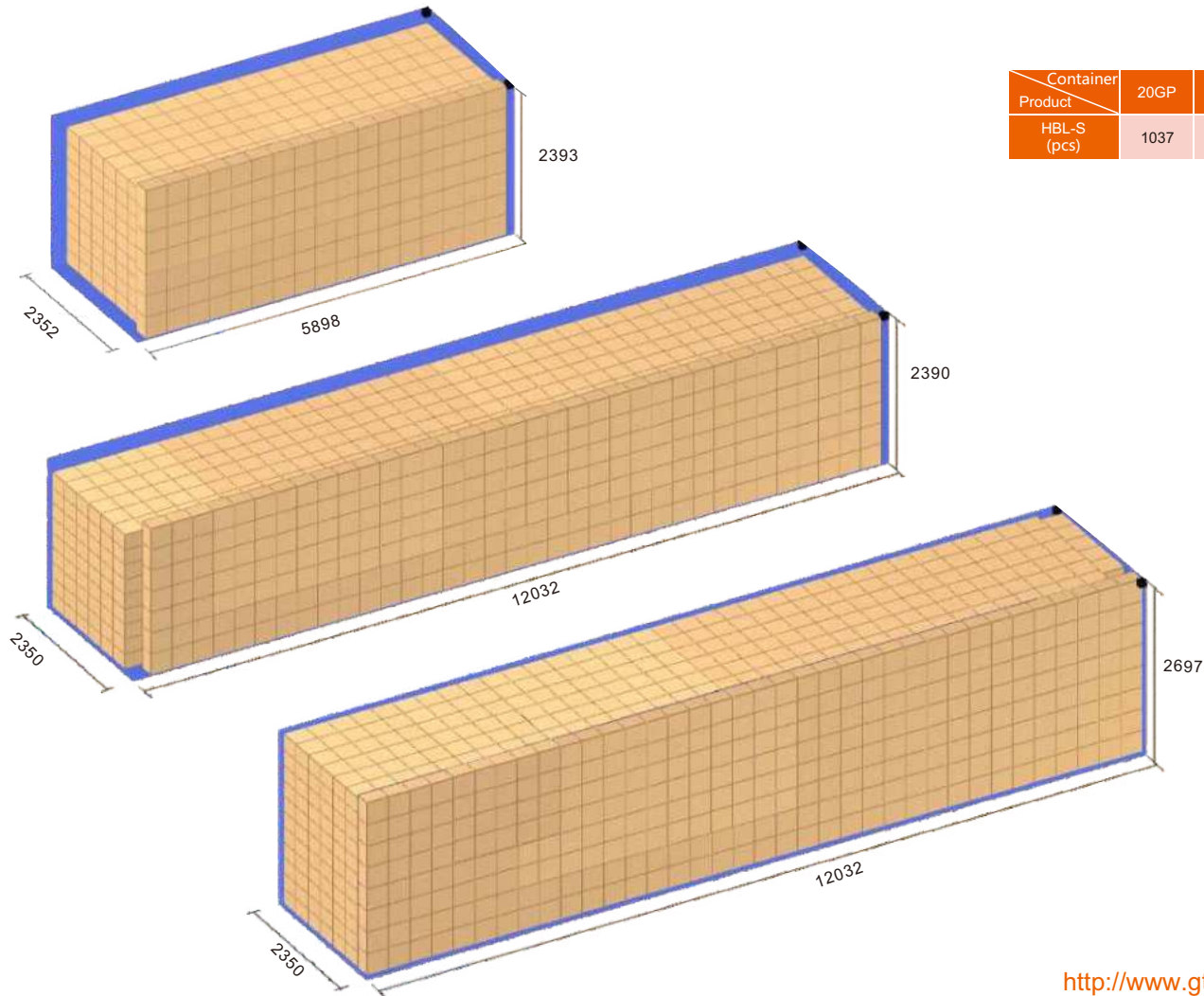
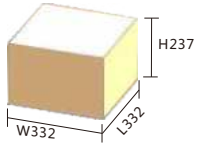

Container Product	20GP	40GP	40HC
HBL-S (pcs)	1037	2189	2663

<http://www.gtlighting.com/>

High Bay Light

GTL Lighting(Shen Zhen)Co.,Ltd.

Container volume calculation

Unit : mm

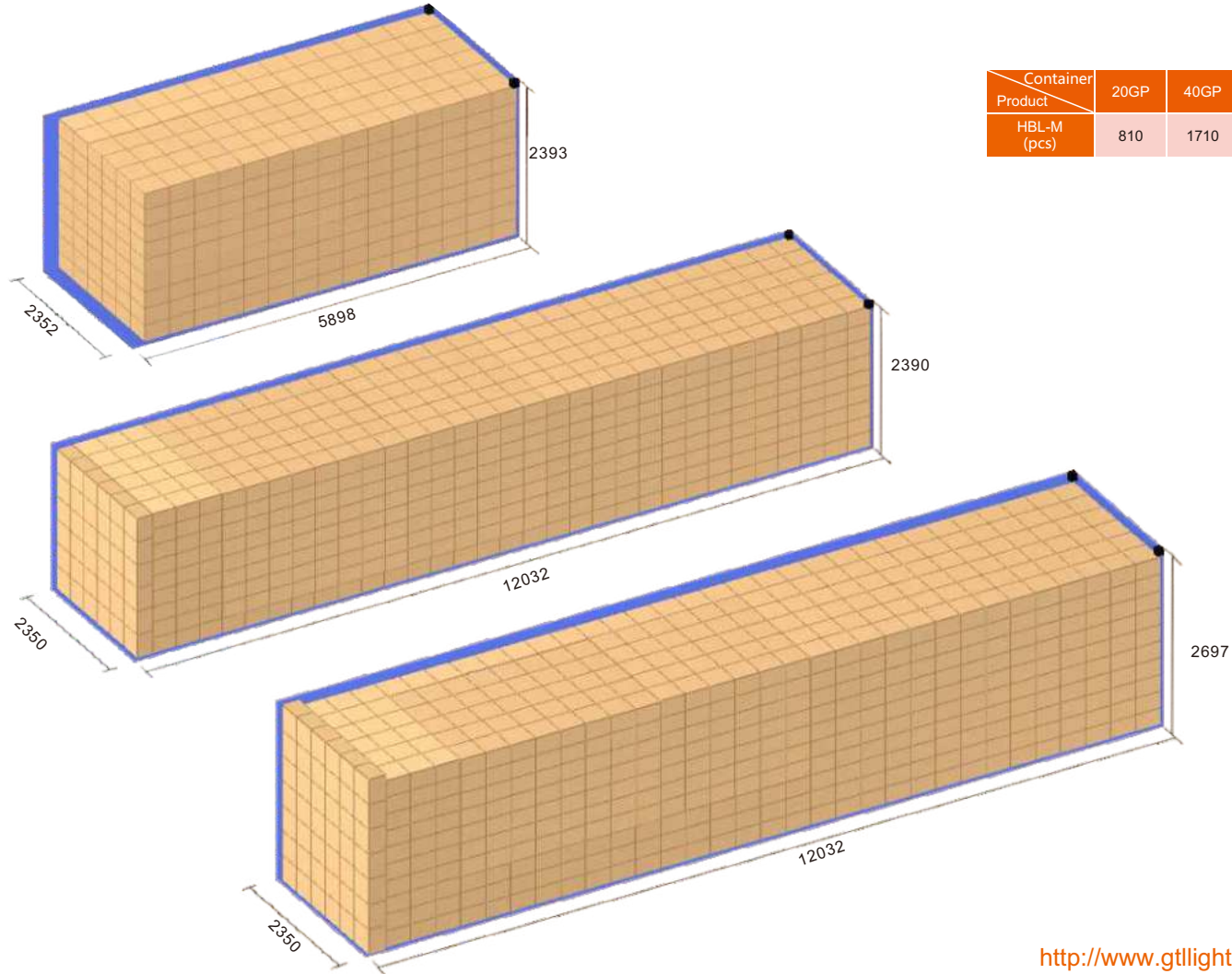
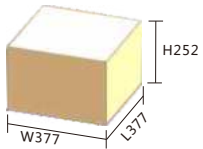

Container Product	20GP	40GP	40HC
HBL-M (pcs)	810	1710	1902

<http://www.gtlighting.com/>

High Bay Light

GTL Lighting(Shen Zhen)Co.,Ltd.

Container volume calculation

Unit : mm

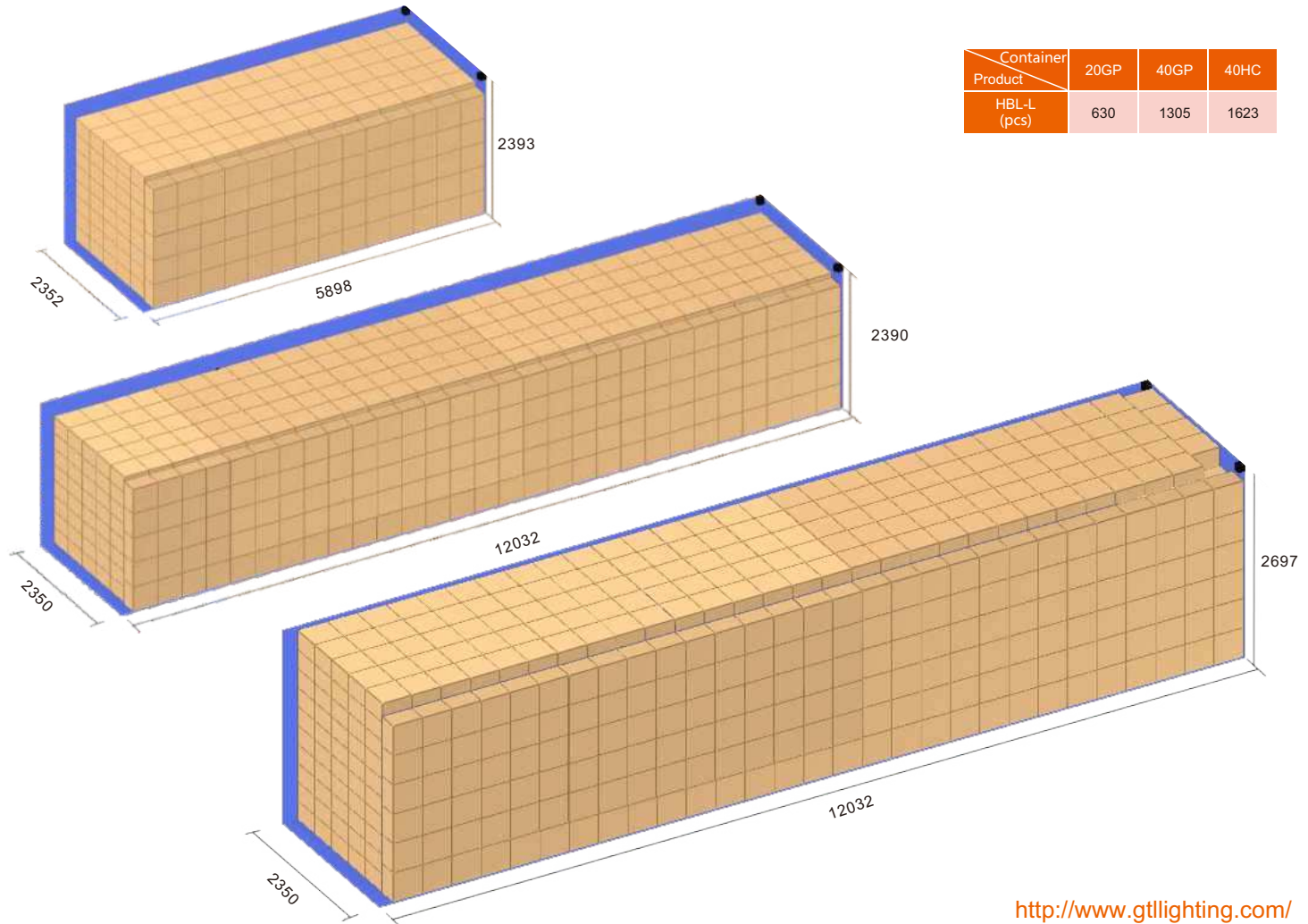
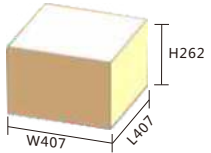

Container Product	20GP	40GP	40HC
HBL-L (pcs)	630	1305	1623

<http://www.gtlighting.com/>

High Bay Light

Container volume calculation

GTL Lighting(Shen Zhen)Co.,Ltd.

Unit : mm

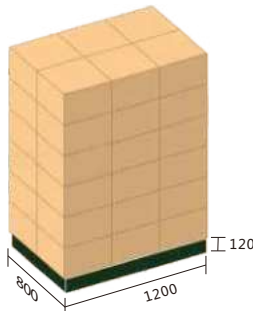
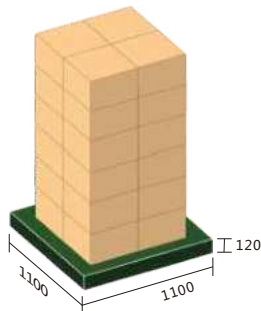
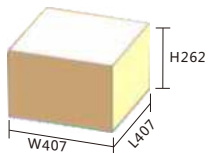
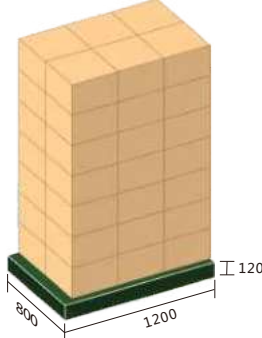
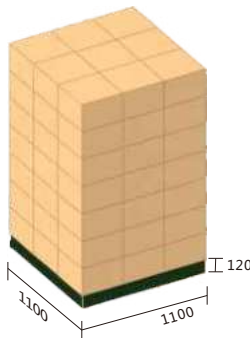
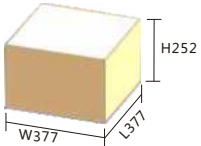
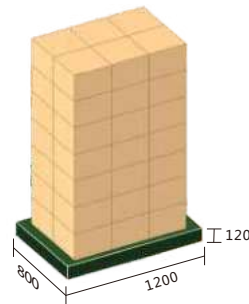
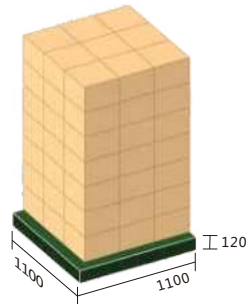
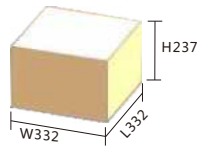

HBL-S	Pallets		Container		
	Pallets(pcs)	pcs product/pallets	20GP	40GP	40HC
	1100*1100*120	63	10	20	20
1200*800*120	42	11	24	24	

HBL-M	Pallets		Container		
	Pallets(pcs)	pcs product/pallets	20GP	40GP	40HC
	1100*1100*120	63	10	20	20
1200*800*120	42	11	24	24	

HBL-L	Pallets		Container		
	Pallets(pcs)	pcs product/pallets	20GP	40GP	40HC
	1100*1100*120	24	10	20	20
1200*800*120	36	11	24	24	

<http://www.gtlighting.com>

It's always a good choice

It's easy to find us
You can contact us in the following ways or leave us a message.
+86-755-2301 9782

GTL Lighting(Shen Zhen)Co.,Ltd.

Address: floor 9, building 1, no. 28 cuijing road, longtian
street, pingshan new district, shenzhen city

Website: www.gtlighting.com