

# High Bay Light

Security  
Reliability

Energy saving  
Smart control



Patent protection

HBL60W-240W



# High Bay Light

Application places

GTL Lighting(Shen Zhen)Co.,Ltd.



**Factory**



**Warehouse**



**High Ceiling**



**Public Area**

<http://www.gtlighting.com/>

# High Bay Light

GTL Lighting(Shen Zhen)Co.,Ltd.

The main characteristics

Safe



Reliability



Energy saving



Smart control



<http://www.gtlighting.com/>

HBL 60/80/100/120/150/200/240W	
HBL-MW 	HBL-MOSO 
<p>The industry's first water-wave circular lens (patented design).its optical loss is only 3% . Circular lens design also provides great convenience to customized projects .More than 200,000pcs are sold worldwide every year, more and more customers are benefiting from this high performance and high reliability product.</p>	

- The workshop
- warehouse
- Airport, station, stadium
- Other industrial and commercial buildings

# High Bay Light

## Product summary

GTL Lighting(Shen Zhen)Co.,Ltd.



### SRGE

- \* 60W-240W
- \* 90-305VAC
- \* 4000K/5000K/5700K
- \* 9000-36000lm
- \* 150lm/W
- \* On/Off (0-10V)
- \* CRI>70
- \* No flicker
- \* SDCM<5
- \* Surge 4KV/6KV
- \* 50,000 hrs @ Ta45°C
- \* IP65, IK10
- \* Hook / Pendant/ Bracket Mount
  
- \* ETL,CE,C-TICK,ROHS
- \* 5years warranty

### Very short payback time

Traditional HID 400W

HBL150W

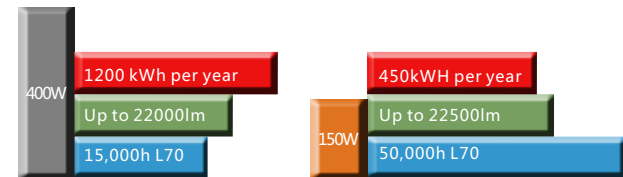

### Fit for different applications

- \*Multiple lumen output
- \* Multiple mounting method
- \*Optional reflector
- \* IP65
- \* Die-casting housing, IK10

### 5 years warranty



Power	60W	80W 100W	120W 150W	200W 240W	
Size (mm)	261*261*118	261**261*172	300*300*190	330*330*201	
Lumen(lm)	9000lm	12000 Lm 15000 Lm	18000 Lm 22500Lm	30000 Lm 36000Lm	
EFF (lm/w)	150lm/W				
Beam Angle	60°/90°/120°				

<http://www.gttlighting.com/>

# High Bay Light

GTL Lighting(Shen Zhen)Co.,Ltd.

Product model

HBL-MW

HBL-MOSO

HBL  
60W



HBL  
80/100W



HBL  
120/150W



HBL  
200/240W



<http://www.gtlighting.com/>

# High Bay Light Specifications

GTL Lighting(Shen Zhen)Co.,Ltd.

		HBL60W	HBL80/100W	HBL120/150W	HBL200/240W
<b>Power</b>		60W	80/100W	120/150W	200/240W
<b>Input Voltage</b>		90-305VAC			
<b>Input Current</b>		0.27A@220VAC	0.36A@220VAC 0.45A@220VAC	0.55A@220VAC 0.68A@220VAC	0.91A@220VAC 1.10A@220VAC
<b>PF</b>		>0.90@220VAC			
<b>DC output voltage</b>		54V	48V		
<b>DC output current</b>		1.05A	1.5A/1.9A	2.3A/2.9A	3.9A/4.65A
<b>Dimming (Optional)</b>		3 in 1 dimming (PWM, 0-10V, Resistor), Dali			
<b>CCT</b>		4000K, 5000K, 5700K, 3000K			
<b>Ra &gt; 80, 5000 k</b>	<b>Luminous Flux</b>	8400 Lm±10%	11200Lm±10% 14000Lm±10%	16800Lm±10% 21000Lm±10%	28000Lm±10% 33600Lm±10%
	<b>Efficiency</b>	140Lm/W±10%			
<b>Ra &gt; 70, 5000 k</b>	<b>Luminous Flux</b>	9000 Lm±10%	12000Lm±10% 15000Lm±10%	18000Lm±10% 22500Lm±10%	30000Lm±10% 36000Lm±10%
	<b>Efficiency</b>	150Lm/W±10%			
<b>LED Brand</b>		Nichia 3030 and Lumileds 3030			
<b>Beam Angle</b>		60°/90°/120°			
<b>Operation Temp</b>		-40°C ~ +45°C			
<b>Storage Temp</b>		-40°C ~ +85°C			
<b>Life Span</b>		45°C 50000hours			
<b>IP Class</b>		IP65			
<b>IK Class</b>		IK10			
<b>Certificate</b>		ETL,CE,C-TICK,ROHS			
<b>Lamp Body Color</b>		Black (default with RAL9005), Gray ( optional for RAL9007)			
<b>MOSO</b>	<b>Product Size (mm)</b>	261*261*188	261*261*188	300*300*208	330*330*218
	<b>Net weight (kg) ±0.1</b>	2.89Kg	2.89Kg	3.87Kg	6.11Kg
	<b>Packing Size (mm)</b>	325*325*230	325*325*230	370*370*245	400*400*255
	<b>Grossweight (kg)±0.1</b>	3.65Kg	3.65	4.79Kg	7.21Kg
<b>MW</b>	<b>Product Size (mm)</b>	261*261*188	261*261*172	300*300*190	330*330*201
	<b>Net weight (kg) ±0.1</b>	2.27Kg	2.95Kg	3.97Kg	6.11Kg
	<b>Packing Size (mm)</b>	325*325*230	325*325*230	370*370*245	400*400*255
	<b>Grossweight (kg)±0.1</b>	3.04Kg	3.7Kg	4.88Kg	7.21Kg
<b>Installation mode</b>		Hook /Pendant /Bracket Mount			

<http://www.gtlighting.com/>

# High Bay Light

Safe/Reliability

GTL Lighting(Shen Zhen)Co.,Ltd.

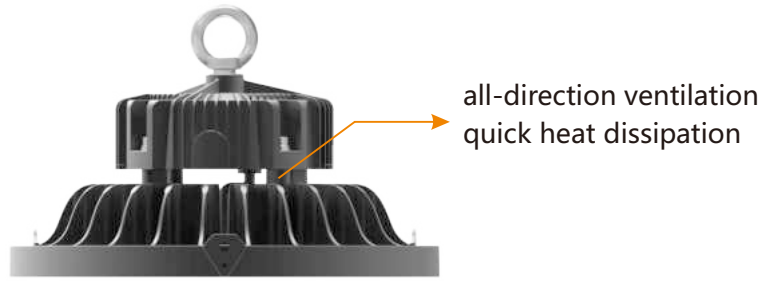
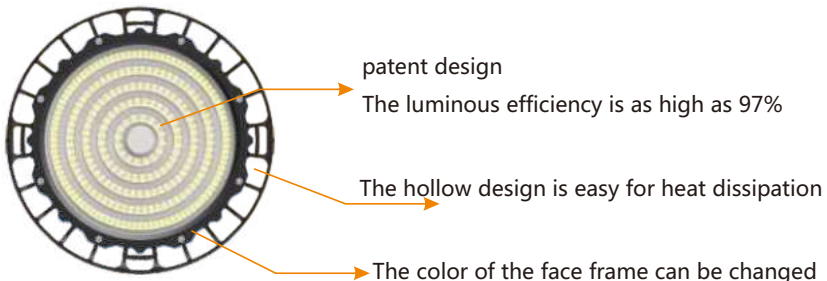
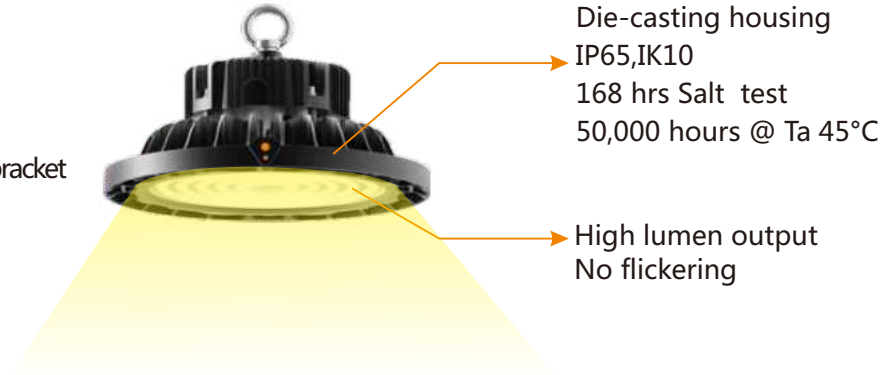
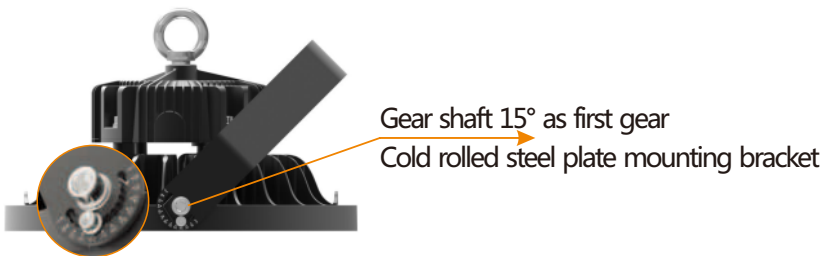

<http://www.gtlighting.com/>



# High Bay Light

GTL Lighting(Shen Zhen)Co.,Ltd.

Configuration table

Configuration							
product name	Product category	Power	CRI	CCT	Distribution	Control	SPD
HBL	High bay	60*/80*/100W	>70	3000/ 4000K	30°/60°	ON/OFF	NO
		120/150/160W	>80	5000/ 5700K	90°	PWM, 0-10V Resistor	
		200*/240W	>90	6500K	120°	DALI	

"\*" Able to be customized, and please contact PM directly

<http://www.gtlighting.com/>

**Customizable table**

	Current	Certification Available	Possibility	Note
<b>Power</b>	100/120/150/ 160/240W	Yes	60/80/200W	The custom code
<b>CCT</b>	3000/4000/ 5000/5700/ 6500K	Yes		The luminous flux will change due to CCT
<b>Beam Angle</b>	60°/90°/120°	Yes	30°	New tooling is required
<b>Control</b>	ON/OFF,0-10V, PWM,DALI	Yes	Microwave	Product out look will be different

# High Bay Light

GTL Lighting(Shen Zhen)Co.,Ltd.

Model description

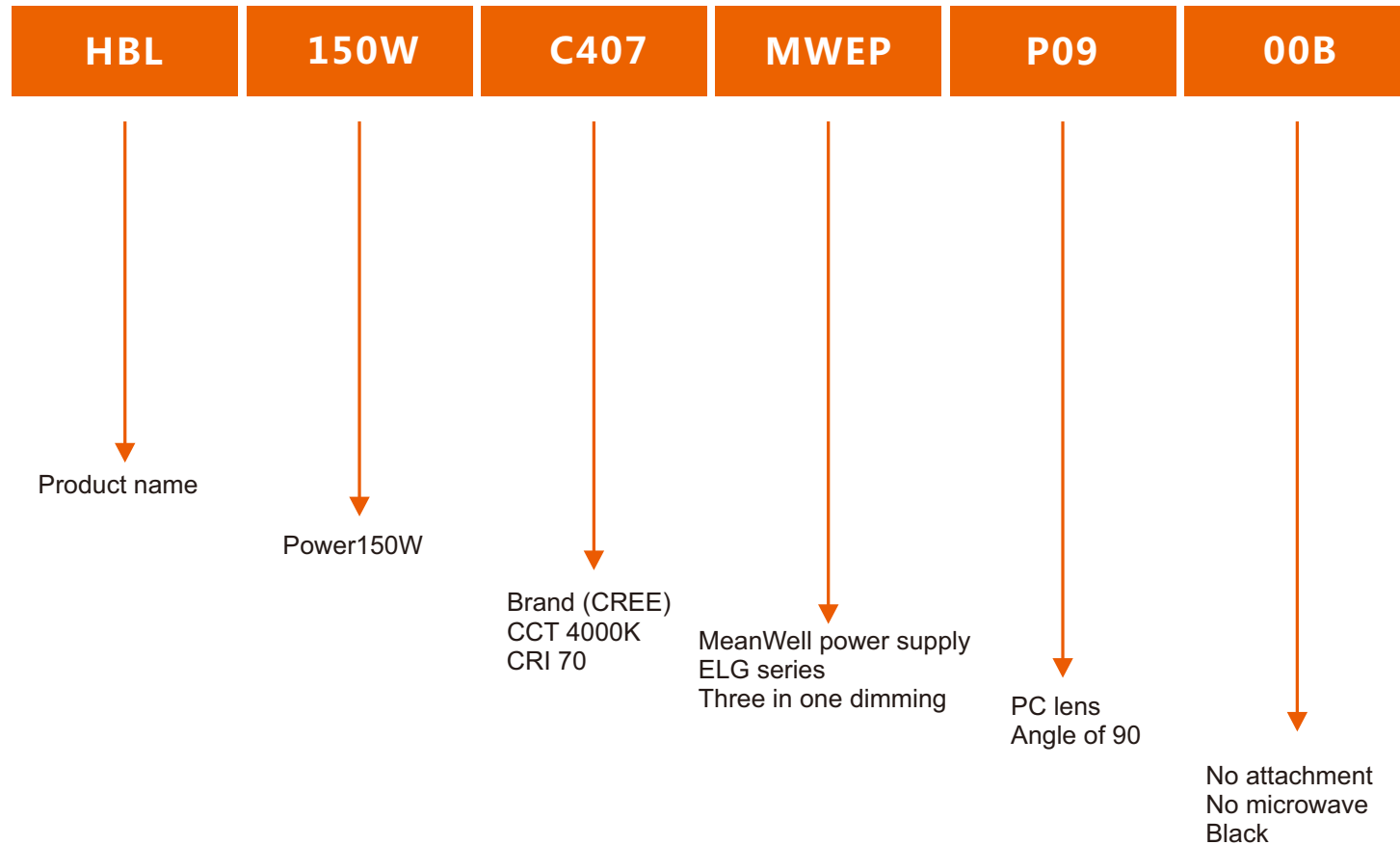

<http://www.gtlighting.com/>

# High Bay Light

## Installation Guide

GTL Lighting(Shen Zhen)Co.,Ltd.

HBL-MW

Wiring diagram

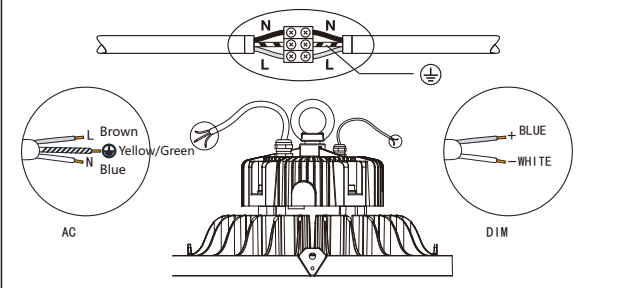

1- Hook Mount

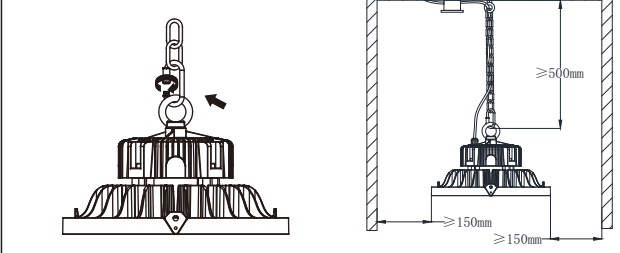

2- Pendant Mount

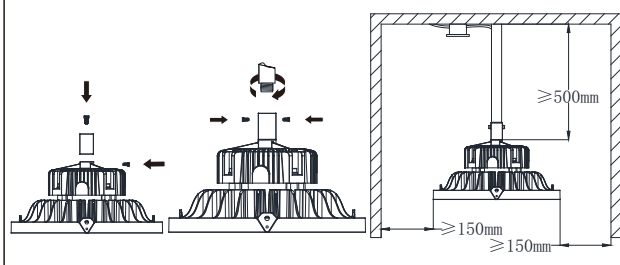

3- Bracket Mount

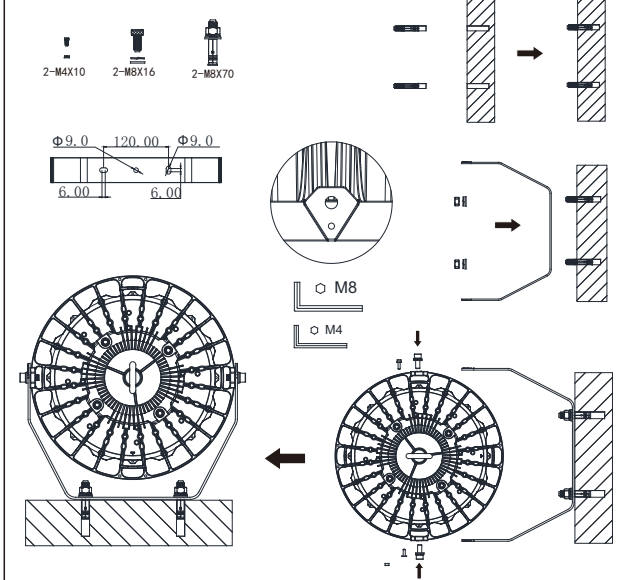

For all of the above installation, it is recommended that all models with safety rope.

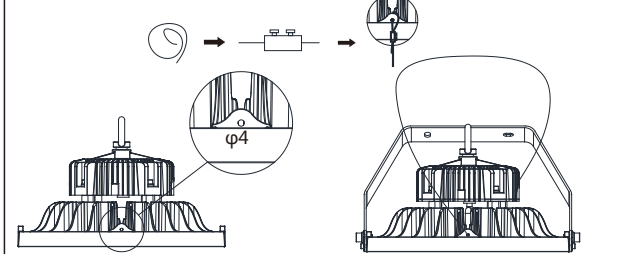

<http://www.gtlighting.com/>

# High Bay Light

## Installation Guide

GTL Lighting(Shen Zhen)Co.,Ltd.

HBL-MOSO

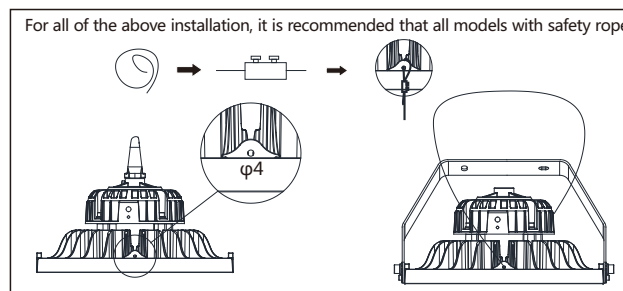
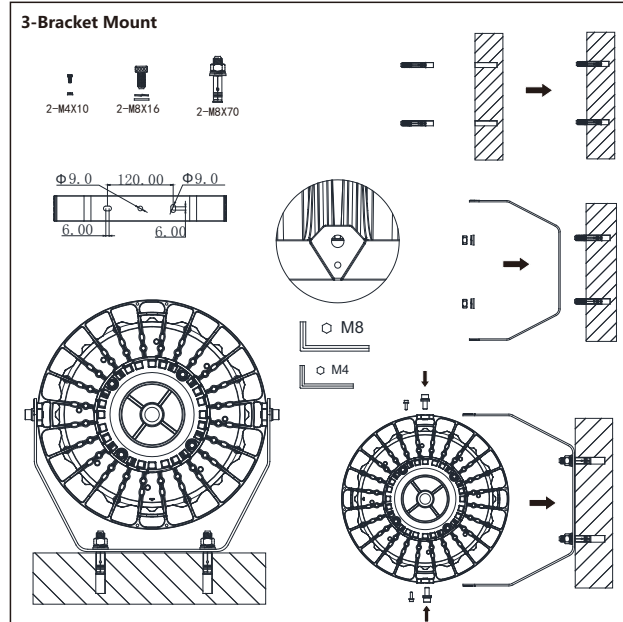
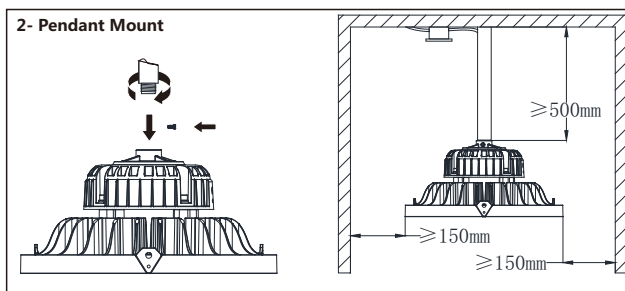
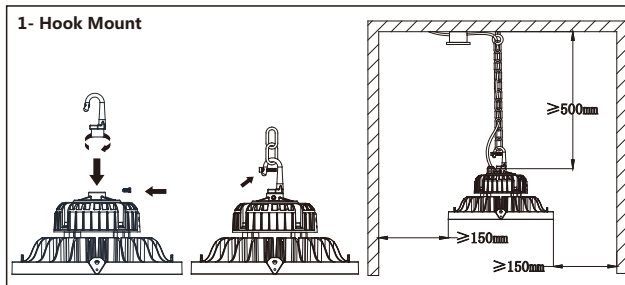
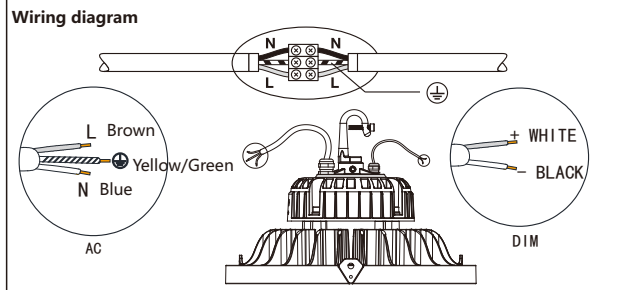

<http://www.gtlighting.com/>

# High Bay Light

GTL Lighting(Shen Zhen)Co.,Ltd.

Container volume calculation

Unit : mm

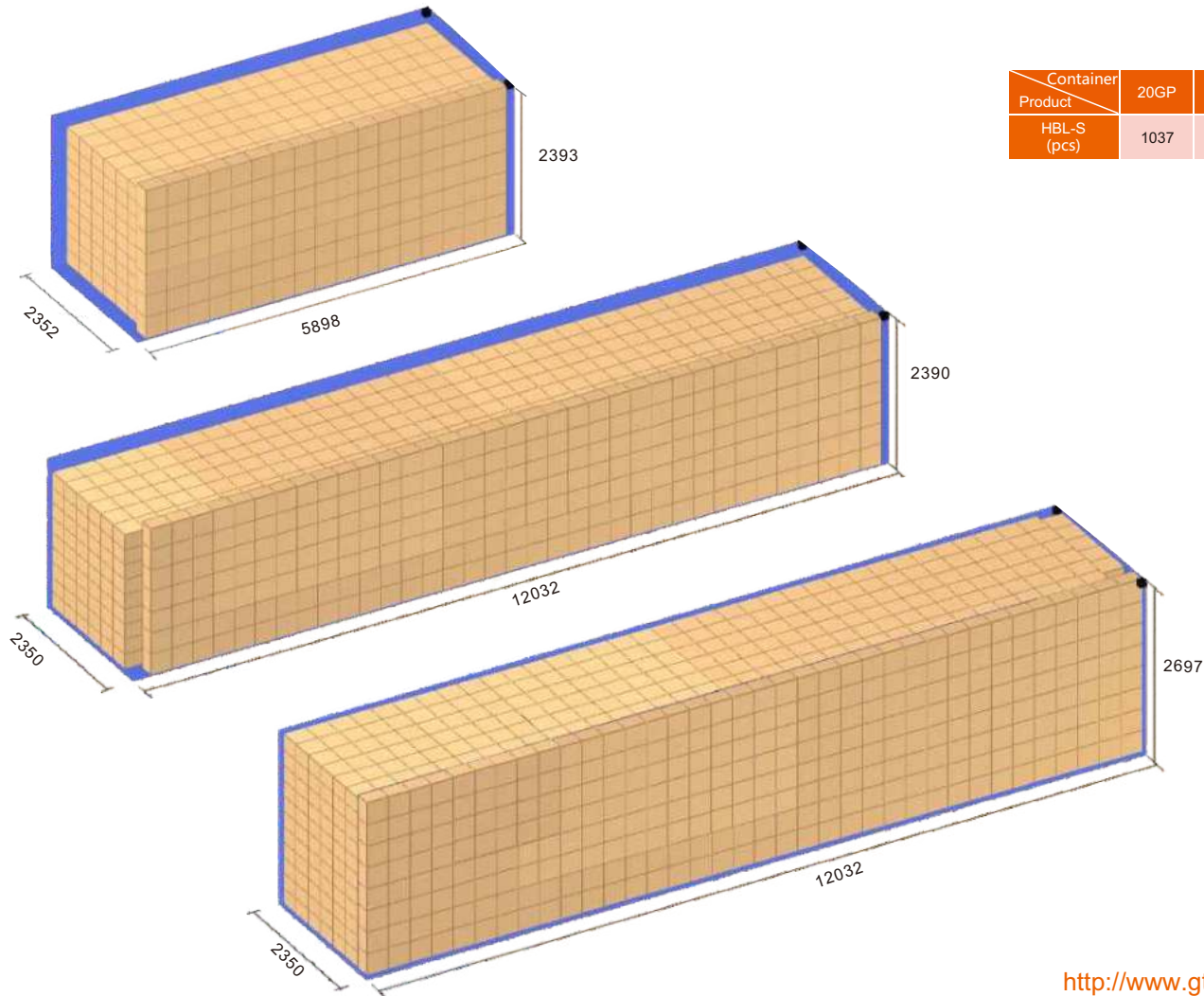
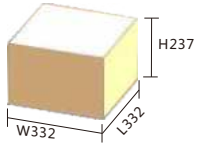

Container Product	20GP	40GP	40HC
HBL-S (pcs)	1037	2189	2663

<http://www.gtlighting.com/>

# High Bay Light

GTL Lighting(Shen Zhen)Co.,Ltd.

Container volume calculation

Unit : mm

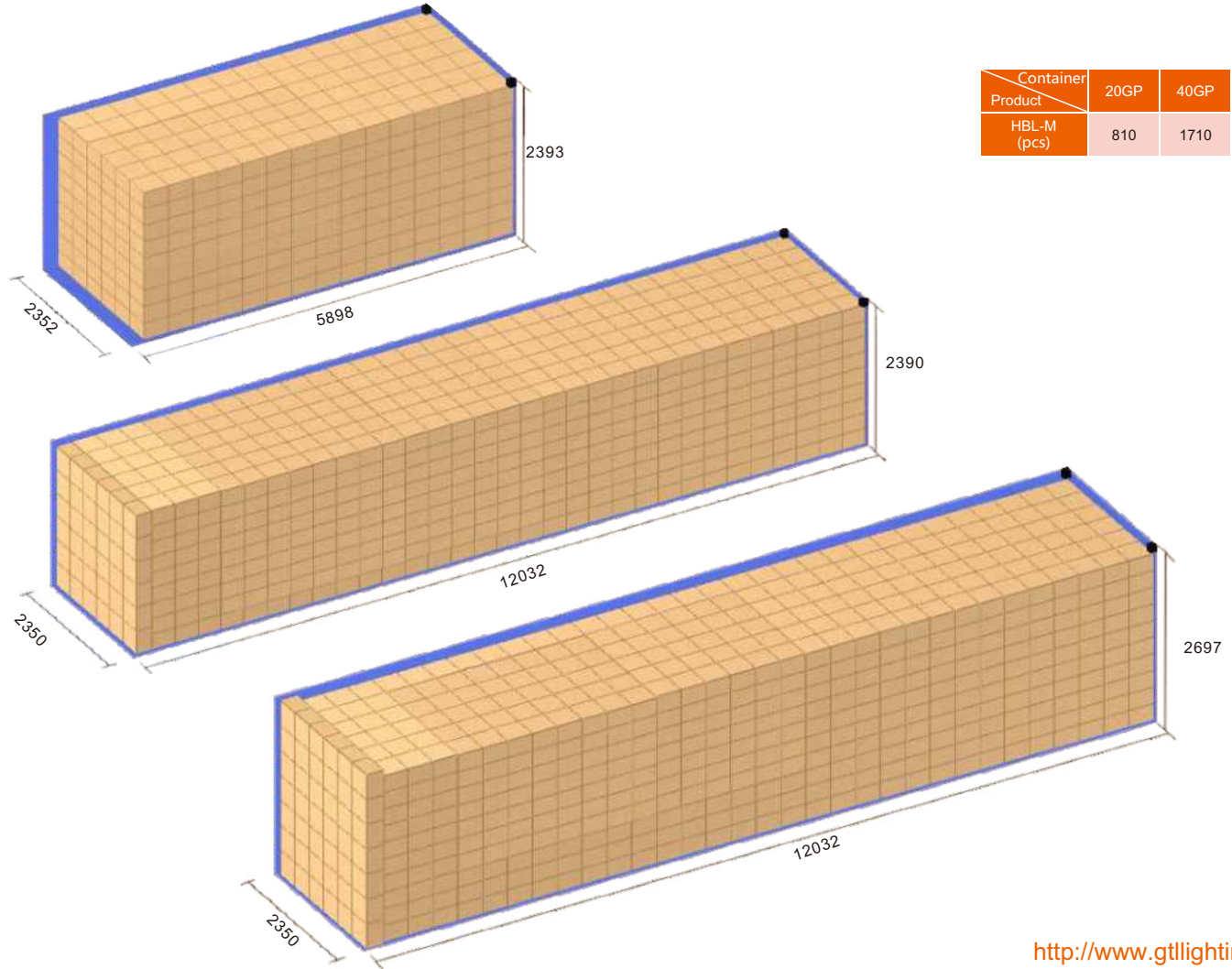
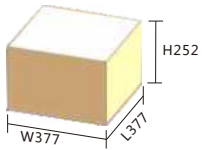

Container Product	20GP	40GP	40HC
HBL-M (pcs)	810	1710	1902

<http://www.gtlighting.com/>

# High Bay Light

GTL Lighting(Shen Zhen)Co.,Ltd.

Container volume calculation

Unit : mm

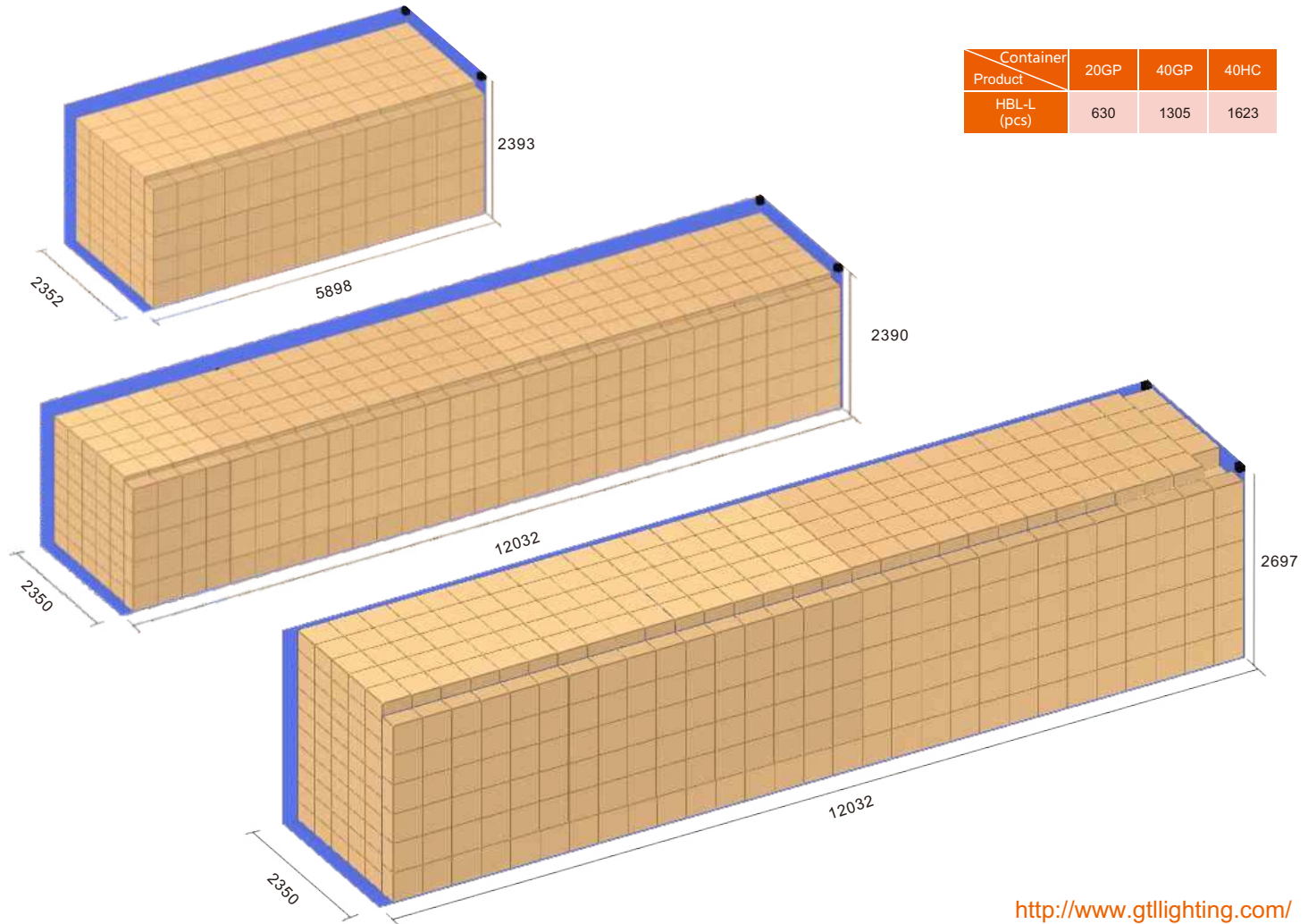
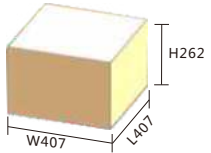

Container Product	20GP	40GP	40HC
HBL-L (pcs)	630	1305	1623

<http://www.gtlighting.com/>



# High Bay Light

## Container volume calculation

GTL Lighting(Shen Zhen)Co.,Ltd.

Unit : mm

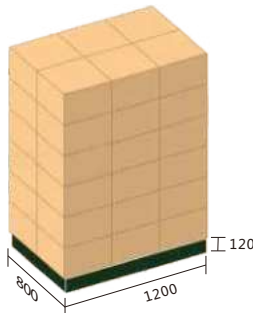
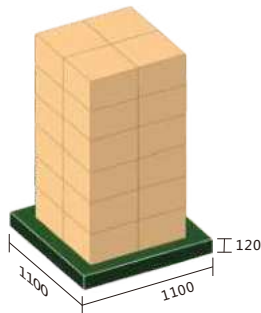
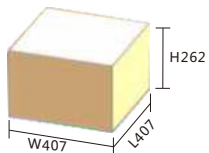
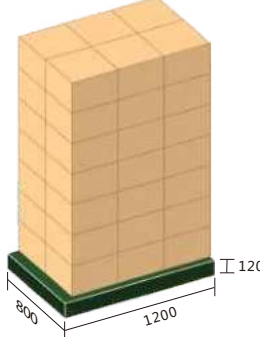
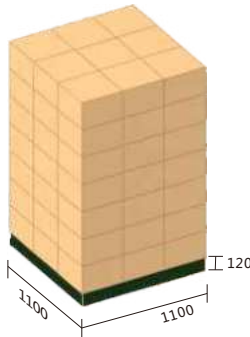
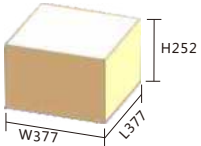
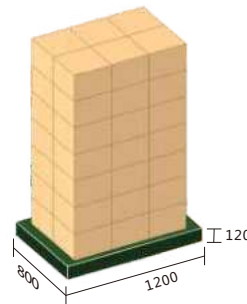
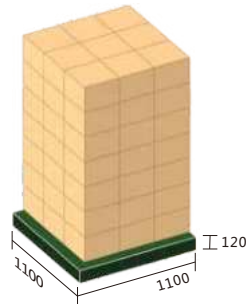
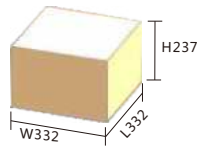

HBL-S	Pallets		Container		
	Pallets(pcs)	pcs product/pallets	20GP	40GP	40HC
	1100*1100*120	63	10	20	20
	Pallets(pcs)	pcs product/pallets			
	1200*800*120	42	11	24	24

HBL-M	Pallets		Container		
	Pallets(pcs)	pcs product/pallets	20GP	40GP	40HC
	1100*1100*120	63	10	20	20
	Pallets(pcs)	pcs product/pallets			
	1200*800*120	42	11	24	24

HBL-L	Pallets		Container		
	Pallets(pcs)	pcs product/pallets	20GP	40GP	40HC
	1100*1100*120	24	10	20	20
	Pallets(pcs)	pcs product/pallets			
	1200*800*120	36	11	24	24

<http://www.gtlighting.com>

# It's always a good choice

It's easy to find us

You can contact us in the following ways or leave us a message.

+86-755-2301 9782

**GTL Lighting(Shen Zhen)Co.,Ltd.**

Address: floor 9, building 1, no. 28 cuijing road, longtian  
street, pingshan new district, shenzhen city

Website: [www.gtlighting.com](http://www.gtlighting.com)